

2023 SALTO

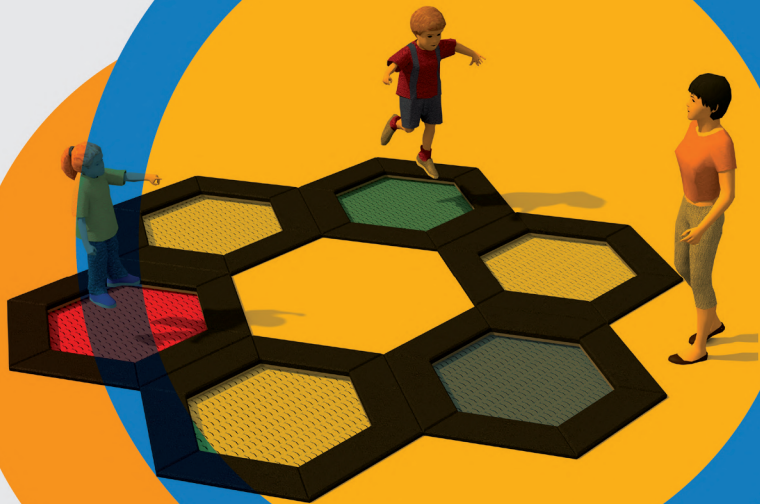

Inter-Play
creating moving space

SALTO

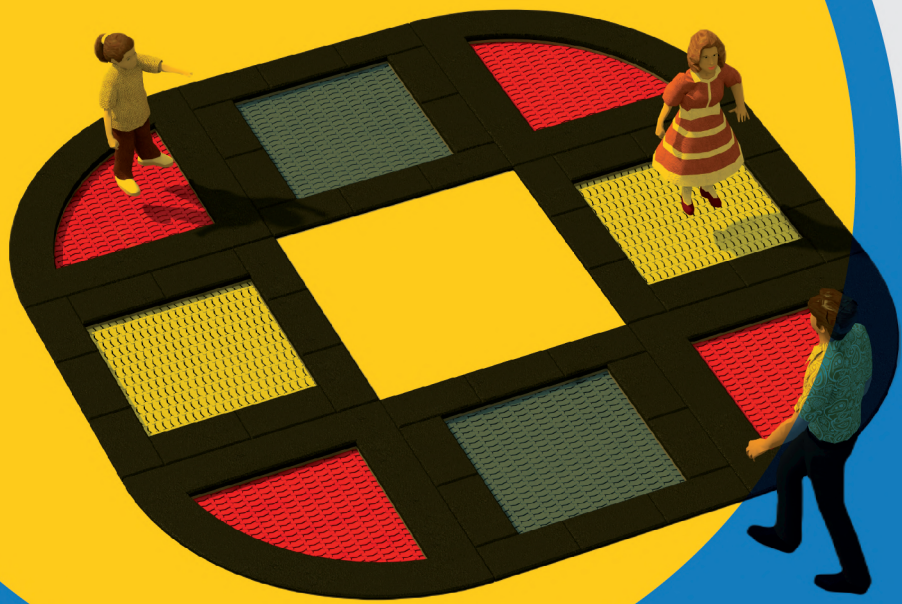



TRAMPOLINES | TRAMPOLINE

Trampoline construction | Konstruktion des Trampolins



Construction | Konstruktion

The body of the trampoline is shaped like a chest. It is made of thick welded sheet metal, which provides stability and durability of the trampoline.

Die Konstruktion des Trampolins besteht aus einem geschweißtem, verzinktem Stahlrahmen. Das gewährleistet die richtige Stabilisierung und gewünschte Lebensdauer des Trampolins.

Springs | Federn

Springs are very durable and allow jumping by bending the mat. They have been made to last for years in public facilities.

Die hochqualitative Feder ermöglichen sanftes Springen, ohne ungewünschten Geräuschen. Die Feder wurden so konzipiert, dass sie für den langjährigen Einsatz in den öffentlichen Bereichen geeignet sind.

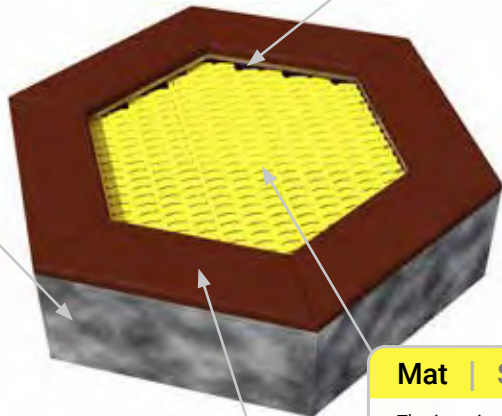

Elastic collar | Fallschutzumrandung

Provides security to user and protects against falling outside the jumping area.

Die integrierte, weiche Umrandung sorgt für die Sicherheit der Nutzer. Sie schützt vor den Verletzungen beim Herausfallen aus der Sprungfläche.

Mat | Sprungmatte

The jumping mat is made of very durable lamellas threaded on steel cables. The lamellas have been designed to be durable and reliable, their specific surface prevents slipping.

Die Sprungmatte wird aus langlebigen und wetterfesten Lamellen gefertigt, die auf Stahldrähten aufgefädelt sind. Die Lamellenform verhindert das Brechen. Ihre spezifische Oberfläche schützt vor dem Verrutschen.



Non-slip surface.
Rutschfeste Oberfläche.

The wide lamella wings provide greater comfort when jumping.
Die breiten Lamellenflügel sorgen für besseren Komfort beim Springen.

Very durable, thick and strong bushings with high resistance for exploitation.
Dicke, sehr starke und langlebige Buchsen mit hoher Verschleißfestigkeit.

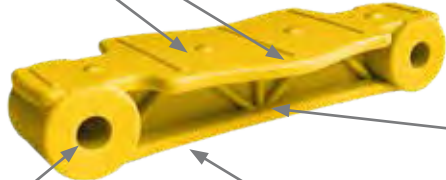

The lamellas are extremely durable thanks to specially designed reinforcements.
Die Lamellen sind dank speziell entwickelter Verstärkungen extrem langlebig.

Thanks to the unique shape of the lamellas, the space between them has been reduced to only 7 mm. This prevents small items such as keys or cell phones from falling inside the trampoline.
Dank der einzigartigen Form der Lamellen wurde der Innenabstand auf nur 7 mm reduziert. Dadurch wird verhindert, dass kleine Dinge wie Schlüssel oder Handys in das Trampolin fallen.

Trampoline construction | Konstruktion des Trampolins

Construction | Konstruktion

The Trampoline body is embedded directly in the ground. It is very stable and durable due to anti corrosion protection by hot - dip galvanizing.

Das Trampolin wird als ein Element in den Boden eingesetzt. Seine solide Konstruktion und Langlebigkeit verdankt es der Feuerverzinkung.

Safe surface | Sicherheitsbereich

There should be a safe surface around the trampoline to protect children from falls.

Um das Trampolin herum sollte ein sicherer Bodenbelag vorhanden sein, der die Kinder vor Sturzfolgen schützt.

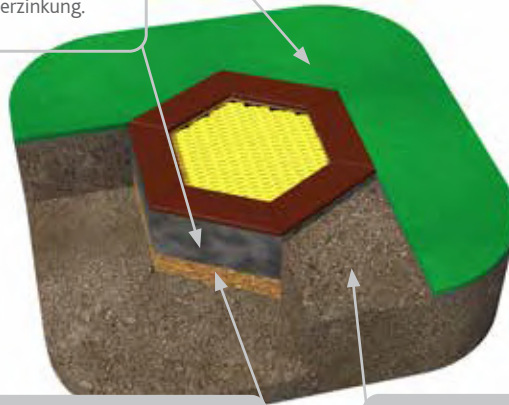

Hardened ground | Befestigter Untergrund

The trampoline is directly mounted on the hardened and levelled ground, which needs to be permeable to water.

Das Trampolin soll direkt auf den befestigten, stabilen Untergrund gesetzt werden. Der Untergrund muss wasserdurchlässig sein.

Ground | Boden

The trampoline is installed in the ground at a depth of 40 cm.

Das Trampolin soll in eine Grubentiefe von 40 cm eingesetzt werden.

Cleaning the inside of the trampoline | Reinigung des Inneraums



Variant I - removing the mat

Variante I - Entfernung der Sprungmatte

To clean the trampoline you need to remove part of the jumping mat. Removing the mat is simple and involves sliding the rope shackles from the springs located along the perimeter of the body of the trampoline.

Um das Trampolin zu reinigen, muss man ein Teil der Sprungmatte entfernen. Um die Sprungmatte zu entfernen, sollen die Seilschäkel von den Federn weggeschoben werden. Die Federn befinden sich auf dem Umfang der Konstruktion.

Variant II - opening the cover

Variante II - Eröffnung des Hebedeckels

Once you open the cover of the trampoline, you can simply clean its inside.

Das Trampolin kann auch durch die einfache Eröffnung von Hebedeckels gereinigt werden.



The colours of the lamellas | Lamellenfarben



black | schwarz
RAL 9005

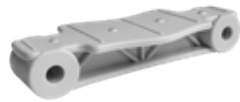

gray | grau
RAL 7035



green | grün
RAL 6029



red | rot
RAL 3020



blue | blau
RAL 5005



violet | violett
RAL 4005



yellow | gelb
RAL 1018



orange | orange
RAL 2005

Patterns on the jumping mat | Sprungmattenmotive

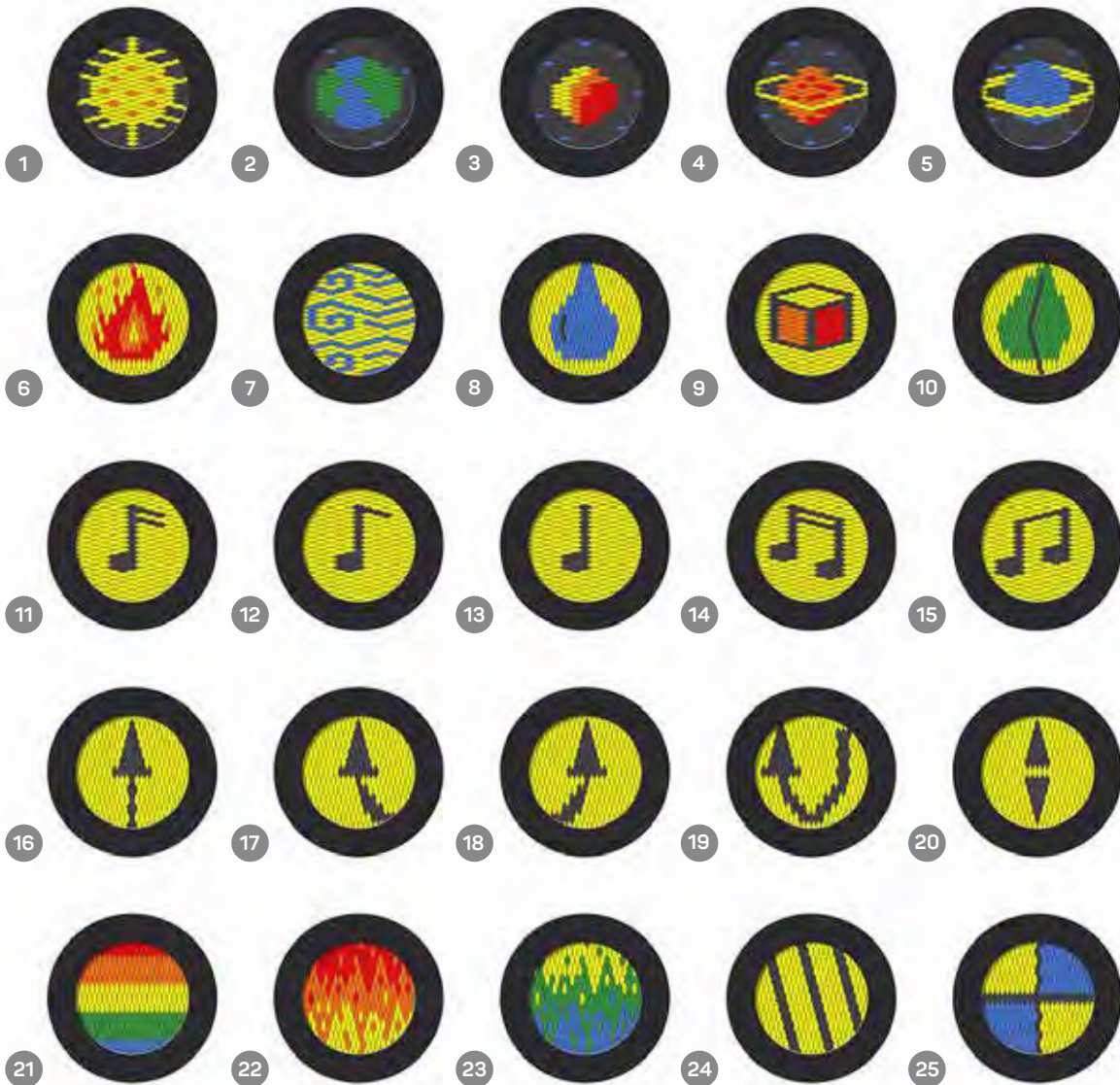

Elastic collar colours | Farben Umrandungsfarben

SBR



red
rot



black
schwarz

EPDM



1002
sand yellow
sandgelb



1012
yellow
gelb



1014
ivory
elfenbein



1015
light ivory
creme



2008
orange
orange



3016
red
rot



3017
rose
rose



4003
heather violet
violett



4005
blue lilac
blau lila

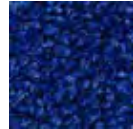

5010
gentian blue
blau

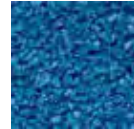

5012
light blue
hellblau

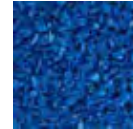

5015
sky blue
himmelblau



6005
moss green
mossegrün



6011
reseda green
erbsengrün

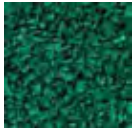

6016
turquoise green
türkisgrün



6017
may green
maigrün



6021
pale green
hellgrün



7011
iron grey
schiefergrau



7037
dusty grey
grau



7038
agate grey
lichtgrau



8024
beige brown
beige braun



8025
pale brown
braun



9004
black
schwarz



9010
pure white
weiß

DESIGN YOUR TRAMPOLINE | GESTALTEN SIE IHR TRAMPOLIN

Create your own unique trampoline - choose a color, pattern, shape and size.

Erstellen Sie Ihr eigenes einzigartiges Trampolin - wählen Sie Farbe, Muster, Form und Größe aus.



SALTO trampoline without an elastic collar are adapted to be covered with a safe surface.

Salto Trampolin ohne elastische Umrandung für den fugenlosen Fallschutzbelag.

1

Trampoline without elastic collar ready for surface installation.

Trampolin ohne Fallschutz ist für die Anwendung des fugenlosen Fallschutzbelags bereit.

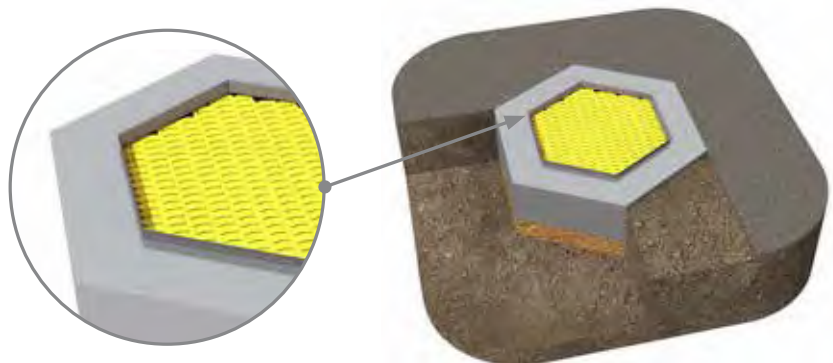

2

Installation of a safe surface using a formwork strip.

Der Ausguß des fugenlosen Fallschutzbelages (vergessen Sie die Schalungsleiste nicht!).

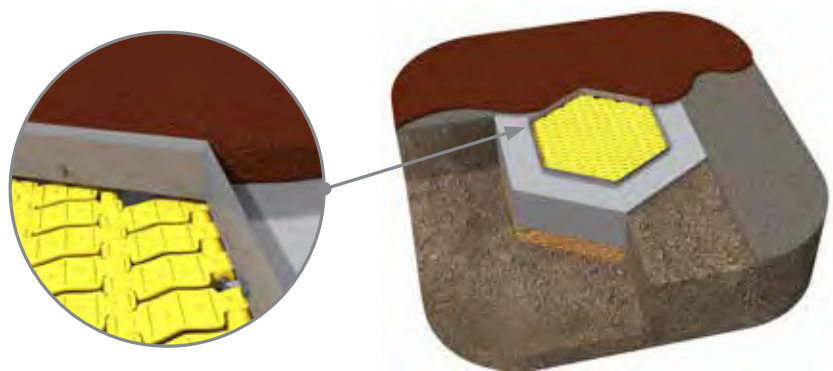

3

The safe surface before removing the formwork strip.

Fertiger Fallschutzbelag vor der Entfernung der Schalungsleiste.

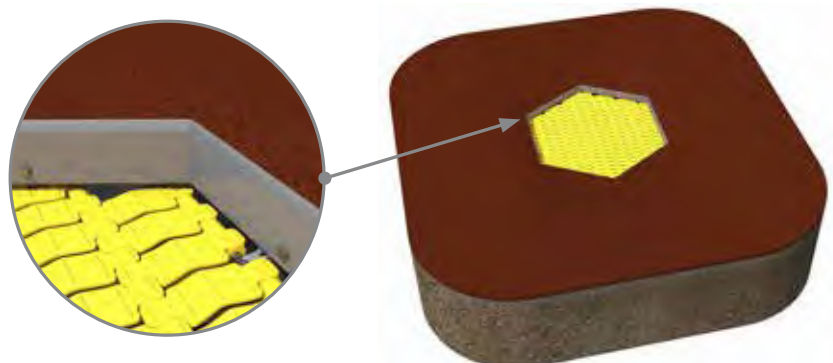

4

Unscrewing and removing the formwork strip. | Die Schalungsleiste kann erst jetzt abgeschraubt und demontiert werden.

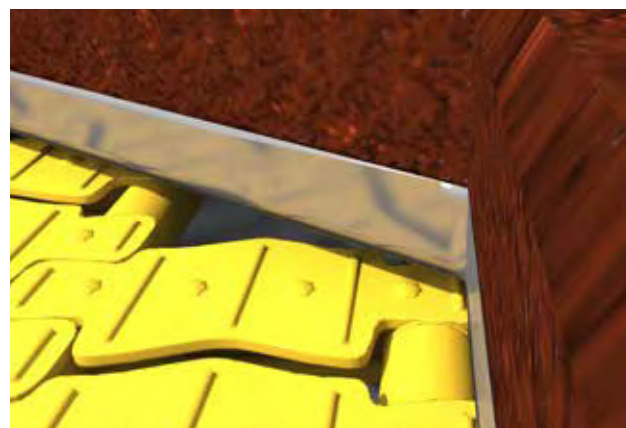



Types of trampolines | Trampolin Arten

Trampoline **PAKO**

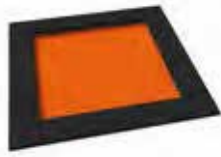

Code	Name	A - dimension	B - jumping area	C - safety area
		A - Trampolingröße	B - Sprungmatte	C - Sicherheitsraum
MA-SA-21	PAKO 125	1,25 x 1,25 m	0,75 x 0,75 m	3,75 x 3,75 m
MA-SA-22	PAKO 150	1,5 x 1,5 m	1,0 x 1,0 m	4,0 x 4,0 m
MA-SA-23	PAKO 175	1,75 x 1,75 m	1,25 x 1,25 m	5,25 x 5,25 m
MA-SA-24	PAKO 200	2,0 x 2,0 m	1,5 x 1,5 m	5,5 x 5,5 m
MA-SA-25	PAKO 225	2,25 x 2,25 m	1,75 x 1,75 m	5,75 x 5,75 m
MA-SA-26	PAKO 250	2,5 x 2,5 m	2,0 x 2,0 m	6,0 x 6,0 m

Trampoline **RADO**



Code	Name	A - dimension	B - jumping area	C - safety area
		A - Trampolingröße	B - Sprungmatte	C - Sicherheitsraum
MA-SA-01	RADO 125	Ø 1,25 m	Ø 0,75 m	Ø 3,75 m
MA-SA-02	RADO 140	Ø 1,4 m	Ø 0,9 m	Ø 3,9 m
MA-SA-03	RADO 150	Ø 1,5 m	Ø 1,0 m	Ø 4,0 m
MA-SA-04	RADO 160	Ø 1,6 m	Ø 1,1 m	Ø 4,1 m
MA-SA-05	RADO 175	Ø 1,75 m	Ø 1,25 m	Ø 4,25 m
MA-SA-06	RADO 200	Ø 2,0 m	Ø 1,5 m	Ø 5,5 m
MA-SA-07	RADO 225	Ø 2,25 m	Ø 1,75 m	Ø 5,75 m

Trampoline **ORTA**



Code	Name	A - dimension	B - jumping area	C - safety area
		A - Trampolingröße	B - Sprungmatte	C - Sicherheitsraum
MA-SA-40	ORTA 125 X 225	1,25 x 2,25 m	0,75 x 1,75 m	3,75 x 4,75 m
MA-SA-41	ORTA 150 X 200	1,5 x 2,0 m	1,0 x 1,5 m	5,0 x 5,5 m
MA-SA-42	ORTA 150 X 225	1,5 x 2,25 m	1,0 x 1,75 m	5,0 x 5,75 m
MA-SA-43	ORTA 150 X 250	1,5 x 2,5 m	1,0 x 2,0 m	5,0 x 6,0 m
MA-SA-44	ORTA 175 X 225	1,75 x 2,25 m	1,25 x 1,75 m	5,25 x 5,75 m
MA-SA-45	ORTA 175 X 250	1,75 x 2,5 m	1,25 x 2,0 m	5,25 x 6,0 m
MA-SA-46	ORTA 150 X 300	1,5 x 3,0 m	1,0 x 2,5 m	5,0 x 6,5 m

Trampoline **ORTA-I**



integrado



Code	Name	A - dimension	B - jumping area	C - safety area
		A - Trampolingröße	B - Sprungmatte	C - Sicherheitsraum
MA-SA-41-I	ORTA-I 150 X 200	1,5 x 2,0 m	1,0 x 1,5 m	5,0 x 5,5 m
MA-SA-43-I	ORTA-I 150 X 250	1,5 x 2,5 m	1,0 x 2,0 m	5,0 x 6,0 m
MA-SA-46-I	ORTA-I 150 X 300	1,5 x 3,0 m	1,0 x 2,5 m	5,0 x 6,5 m
MA-SA-47-I	ORTA-I 150 X 500	1,5 x 5,0 m	1,0 x 4,5 m	5,0 x 8,5 m

- A - trampoline dimension | Trampolingröße
- B - the size of the jumping mat | Größe der Sprungmatte
- C - safety area | Sicherheitsraum

Other dimensions are available on request!
Andere Abmessungen sind auf Anfrage lieferbar!

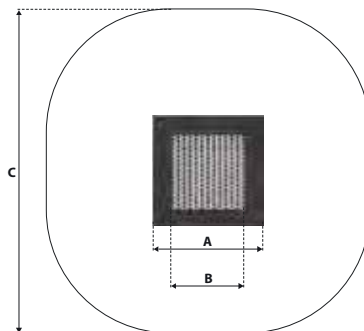

Trampoline **HEXO**



Code	Name	A - dimension	B - jumping area	C - safety area
		A - Trampolingröße	B - Sprungmatte	C - Sicherheitsraum
MA-SA-61	HEXO 1	1,7 x 1,47 m	1,14 x 0,97 m	4,14 x 3,97 m

Trampoline **PENTO**

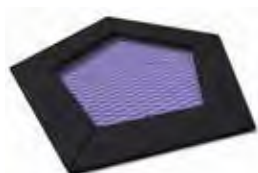

Code	Name	A - dimension	B - jumping area	C - safety area
		A - Trampolingröße	B - Sprungmatte	C - Sicherheitsraum
MA-SA-51	PENTO 1	1,68 x 1,6 m	1,18 x 1,5 m	4,68 x 4,6 m

Trampoline **KVARTALO**



Code	Name	A - dimension	B - jumping area	C - safety area
		A - Trampolingröße	B - Sprungmatte	C - Sicherheitsraum
MA-SA-71	KVARTALO 125	1,25 x 1,25 m	0,75 x 0,75 m	3,75 x 3,75 m
MA-SA-72	KVARTALO 150	1,5 x 1,5 m	1,0 x 1,0 m	4,0 x 4,0 m
MA-SA-73	KVARTALO 175	1,75 x 1,75 m	1,25 x 1,25 m	5,25 x 5,25 m
MA-SA-74	KVARTALO 200	2,0 x 2,0 m	1,5 x 1,5 m	5,5 x 5,5 m
MA-SA-75	KVARTALO 225	2,25 x 2,25 m	1,75 x 1,75 m	5,75 x 5,75 m
MA-SA-76	KVARTALO 250	2,5 x 2,5 m	2,0 x 1,0 m	6,0 x 6,0 m

Trampoline **JUNTO**



Code	Name	A - dimension	B - jumping area	C - safety area
		A - Trampolingröße	B - Sprungmatte	C - Sicherheitsraum
MA-SA-93	JUNTO 150 x 225	1,5 x 2,25 m	1,0 x 1,75 m	4,0 x 4,75 m



CREATE YOUR OWN SET OF TRAMPOLINE | KREIEREN SIE IHR EIGENES TRAMPOLIN-SET

3x



=



4x



=



6x

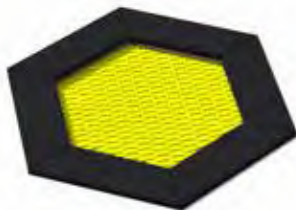

=



13x

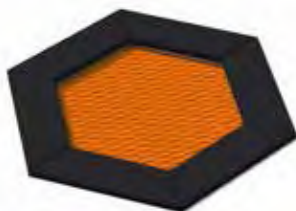

=



HEXO 6A
MA-SA-67

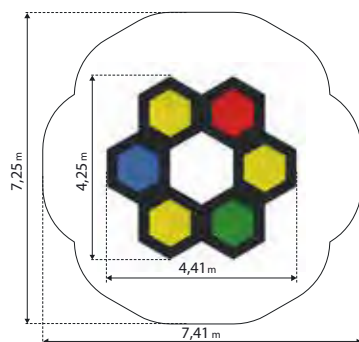

HEXO 4A
MA-SA-64

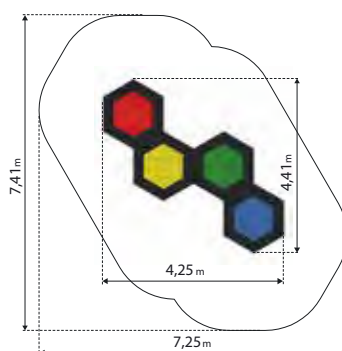

HEXO 3A
MA-SA-62

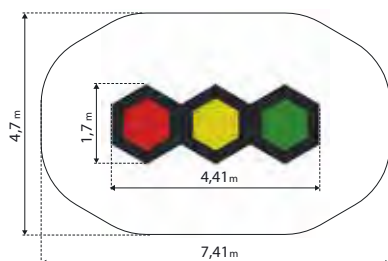

HEXO 3B
MA-SA-63

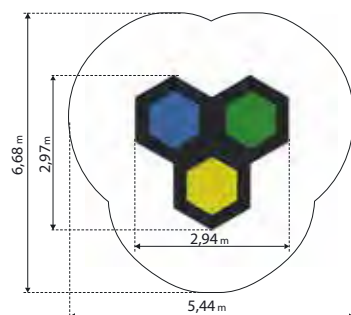

HEXO 5A
MA-SA-66

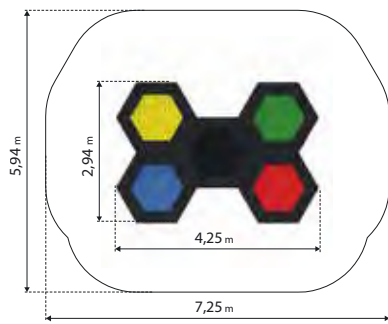

HEXO 4B
MA-SA-65

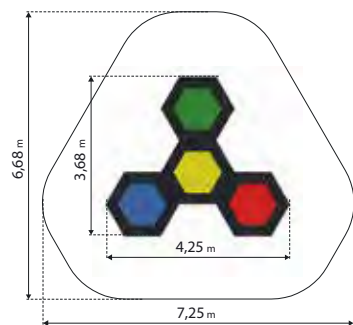

HEXO 13A
MA-SA-69

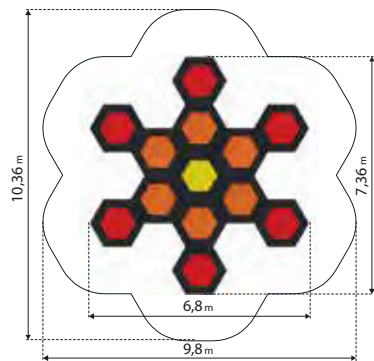

HEXO 7A
MA-SA-68

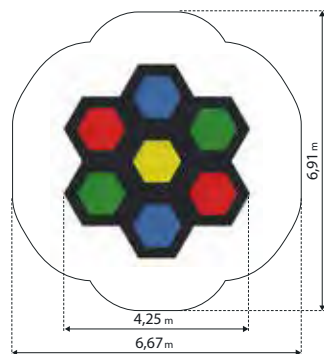

TUTO 1
MA-SA-101

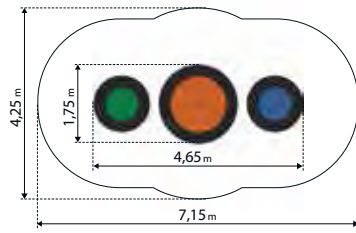

TUTO 2
MA-SA-102

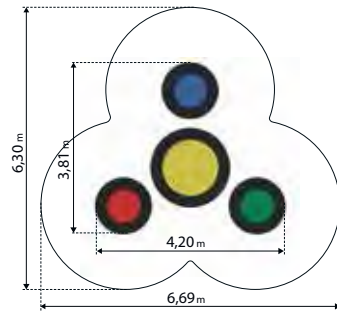

TUTO 3
MA-SA-102

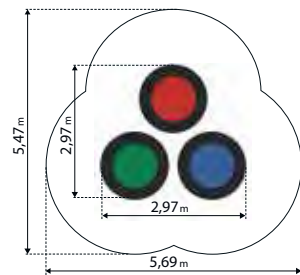

TUTO 4
MA-SA-104

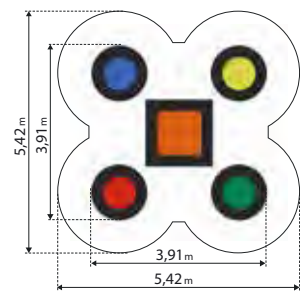

TUTO 5
MA-SA-105

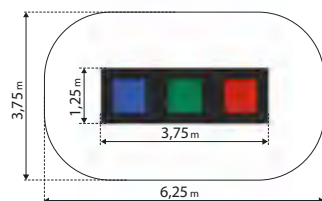

TUTO 6
MA-SA-106

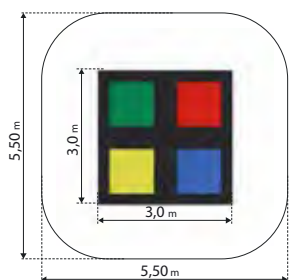

TUTO 7
MA-SA-107

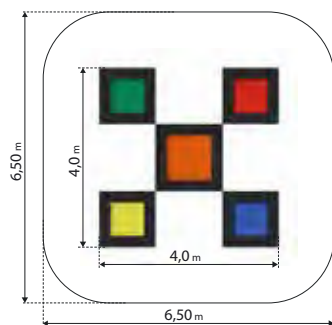

TUTO 8
MA-SA-108

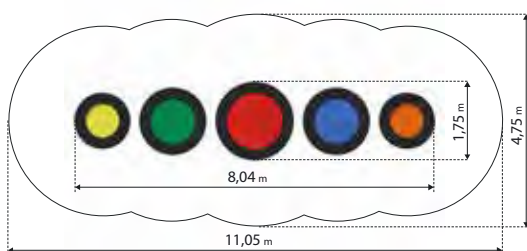

TUTO 9
MA-SA-109

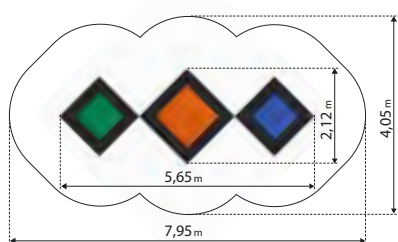

TUTO 10
MA-SA-110

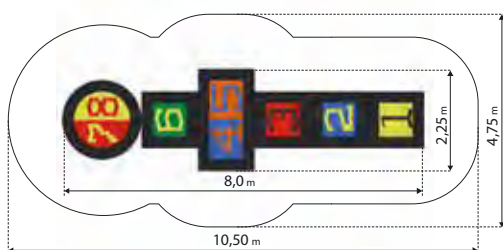

TUTO 11
MA-SA-111

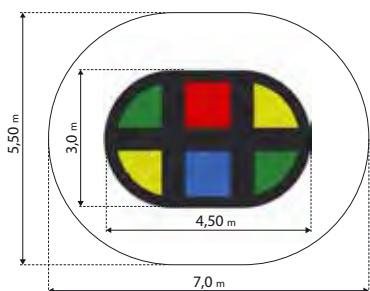

TUTO 12
MA-SA-112

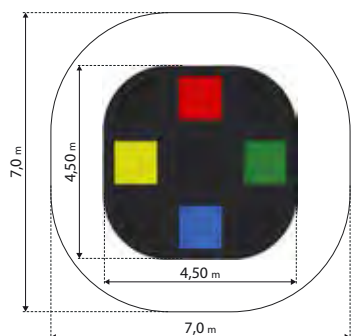

TUTO 13
MA-SA-112

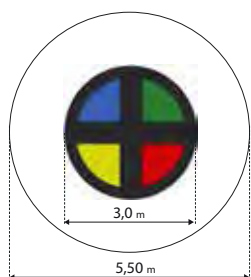

TUTO 14
MA-SA-114

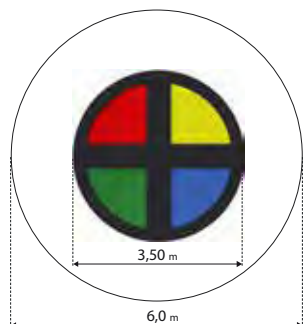

TUTO 15
MA-SA-115

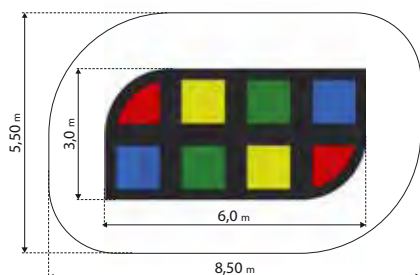

TUTO 16
MA-SA-116

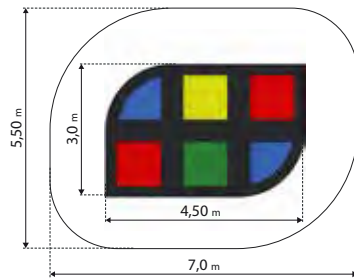

TUTO 17
MA-SA-117

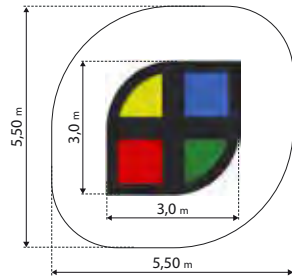

TUTO 18
MA-SA-118

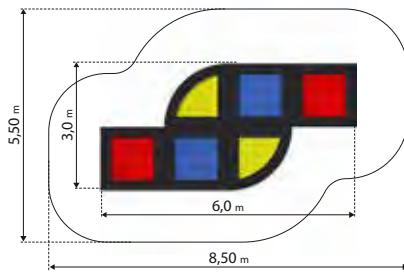

TUTO 19
MA-SA-119

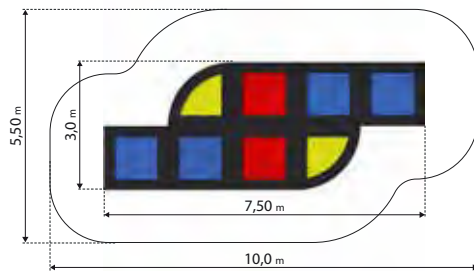

TUTO 20
MA-SA-120

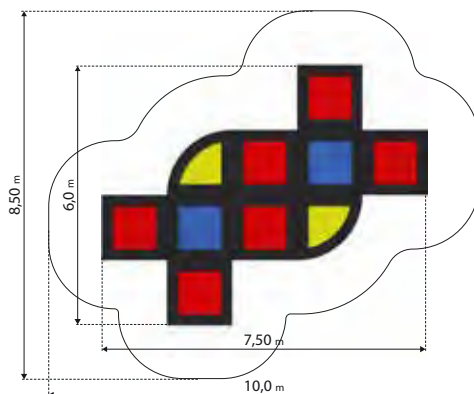

TUTO 21
MA-SA-121

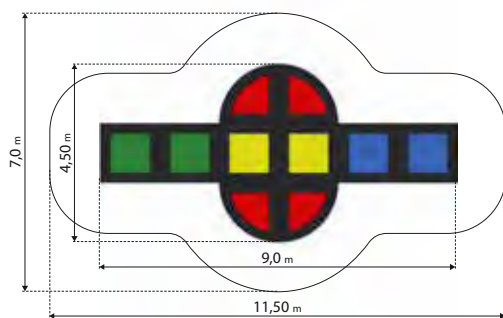

TUTO 22
MA-SA-122

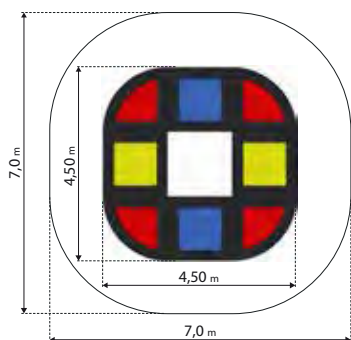

TUTO 23
MA-SA-123

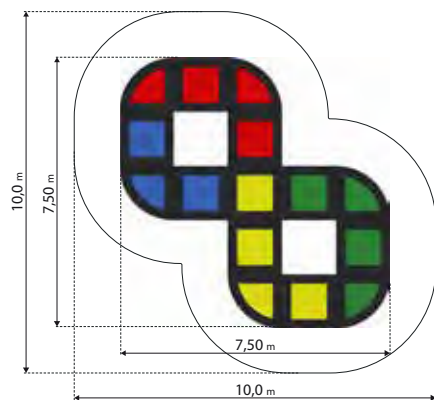

TUTO 24
MA-SA-124

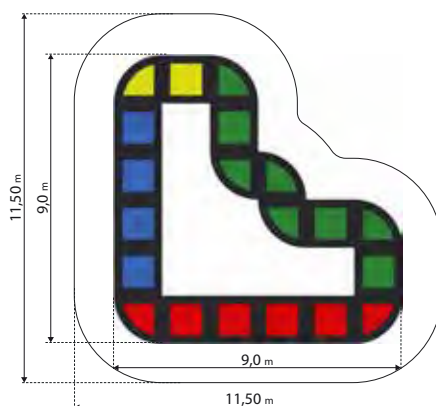

TUTO 25
MA-SA-125

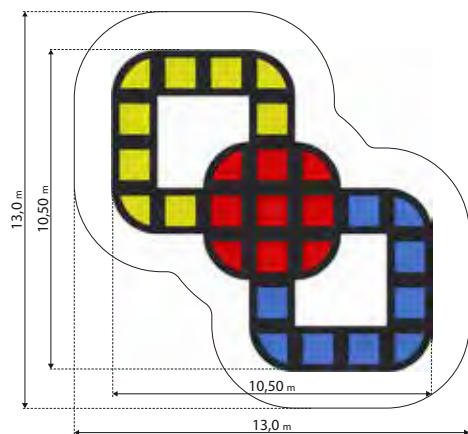

TUTO 26
MA-SA-126

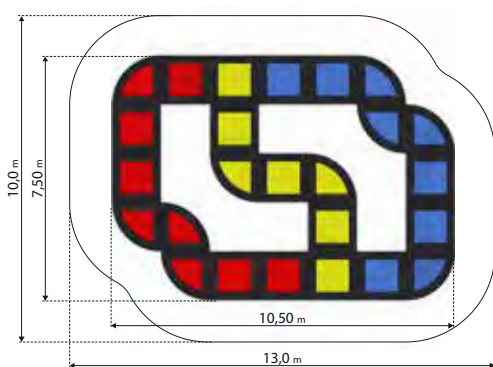

TUTO 27
MA-SA-127

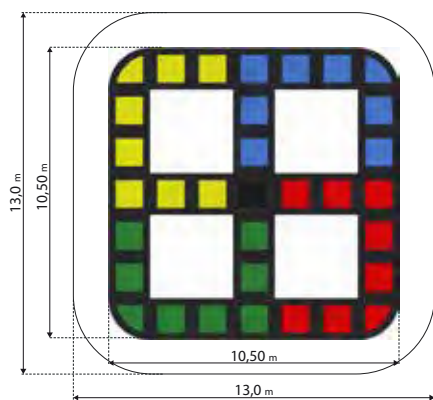

TUTO 28
MA-SA-128

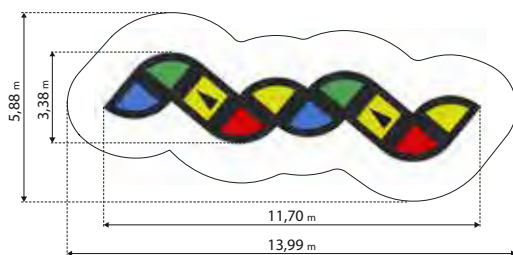

TUTO 29
MA-SA-129

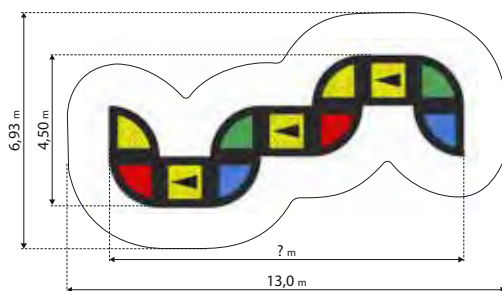

TUTO 30
MA-SA-130

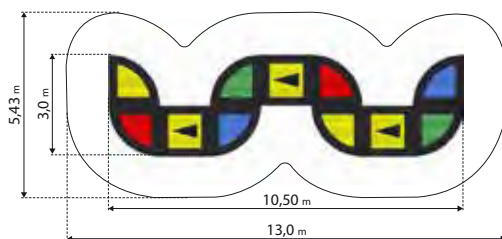

TUTO 31
MA-SA-131

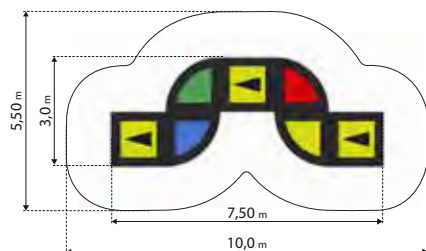

ORTA-I 150 X 200

MA-SA-41-I

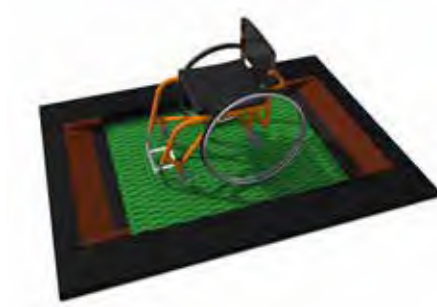
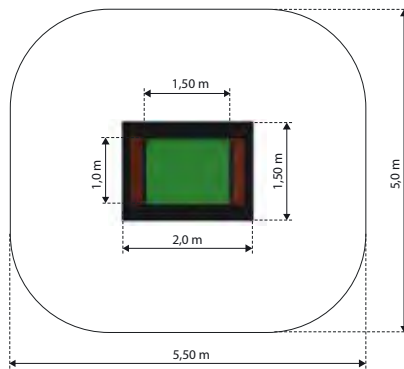

ORTA-I 150 X 250

MA-SA-43-I

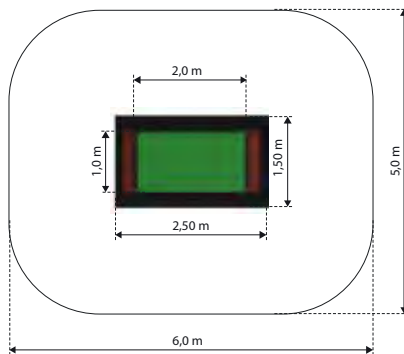

ORTA-I 150 X 300

MA-SA-46-I

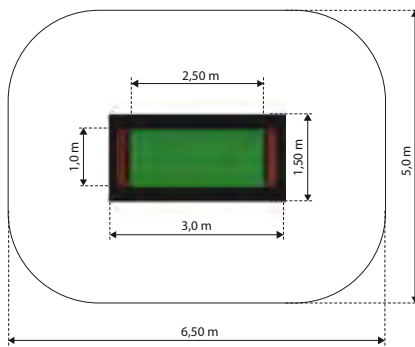

ORTA-I 150 X 500

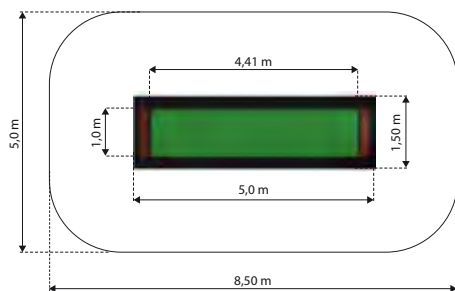

MA-SA-47-I





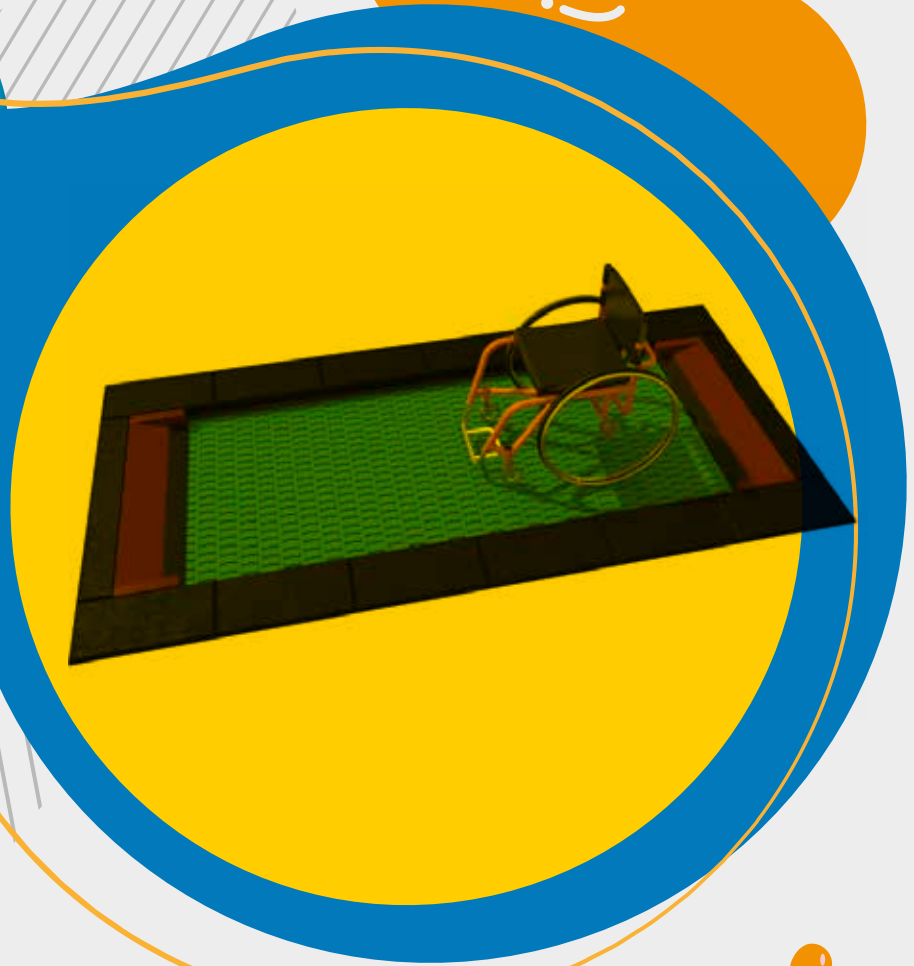



 **Deutschland**
 **Österreich**

info@interplay-spiel.de
www.interplay-spiel.de
Büro: +48 915 065 044

Aleksandra +49 170 655 12 87
Region: Süddeutschland, Westösterreich

Małgorzata +49 160 996 499 41
Region: Norddeutschland, Ostösterreich